

TT-S2B PILOT OPERATED POPPET, 2 WAY NORMALLY CLOSED

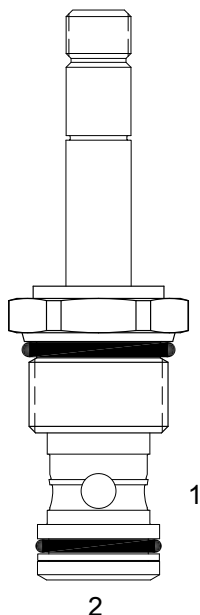

DESCRIPTION

12 size, 1 1/16-12 thread, "Tecnord" series, solenoid operated, 2 way normally closed, pilot operated poppet valve with reverse flow energized and de-energized.

OPERATION

When de-energized the TT-S2B blocks flow from (1) to (2) and allows reverse flow from (2) to (1). When energized the valve allows flow from (1) to (2) and from (2) to (1).

OPERATION OF MANUAL OVERRIDE OPTION: to override, pull knob out. On the detented version, after pulling knob out twist 180 degrees and release. The valve will remain in that position.

FEATURES

- Hardened parts for long life.
- Efficient wet-armature construction.
- Cartridges are voltage interchangeable.
- Manual override option.
- Industry common cavity.
- Unitized, molded coil design.
- Continuous duty rated solenoid.
- Optional coil voltages and terminations.
- Optional "I" Coil: Weatherproof, Thermal Shock, Immersion Safe.

HYDRAULIC SYMBOL

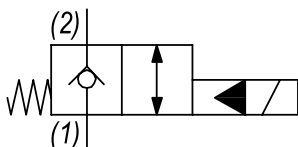

PERFORMANCE

Actual Test Data (Cartridge Only)

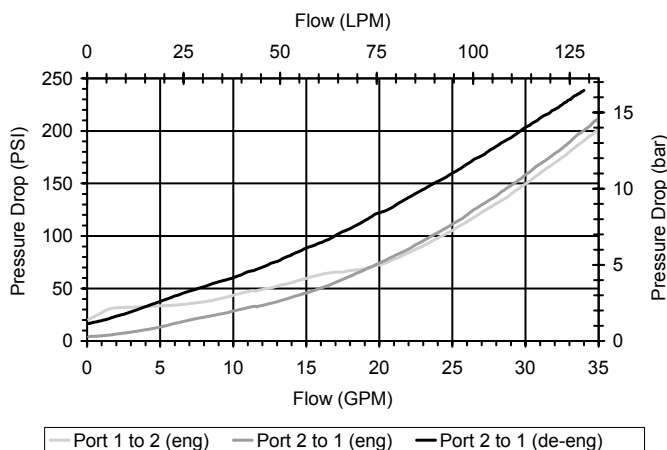

VALVE SPECIFICATIONS

Nominal Flow	25 GPM (95 LPM)
Rated Operating Pressure	3000 PSI (207 bar)
Typical Internal Leakage (150 SSU)	0-5 drops/min
Viscosity Range	36 to 3000 SSU (3 to 647 cSt)
Filtration	ISO 18/16/13
Media Operating Temp. Range	-40° to 250°F (-40° to 120°C)
Weight	.49 lbs (.22 kg)
Operating Fluid Media	General Purpose Hydraulic Fluid
Cartridge Torque Requirements	50 ft-lbs (67.8 Nm)
Coil Nut Torque Requirements	4-6 ft-lbs (5.4-8.1 Nm)
Cavity	TECNORD 2W
Cavity Tools Kit	
(form tool, reamer, tap)	40500032
Seal Kit	21191300

WARNING: the specifications/application data shown in our catalogs and data sheets are intended only as a general guide for the product described (herein). Any specific application should not be undertaken without independent study, evaluation, and testing for suitability.



4484 Boeing Drive Rockford, IL 61109 • USA • Phone +1 (815) 397-6628 • Fax +1 (815) 397-2526
mail: delta@delta-power.com • www.delta-power.com



Via Malavolti, 36 • 41122 Modena • ITALY • Phone +39 (059) 254895 • Fax +39 (059) 253512
mail: tecnord@tecnord.com • www.tecnord.com

DIMENSIONS

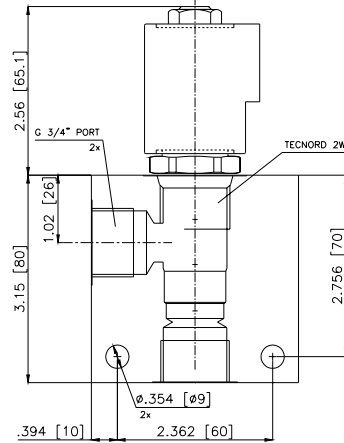
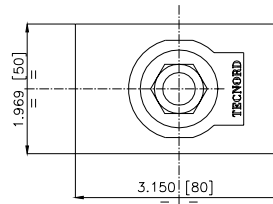
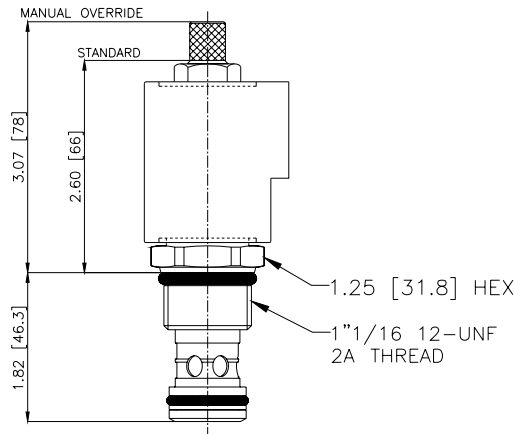
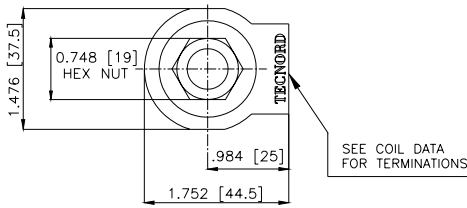

ORDERING INFORMATION

Approximate Coil Weight: .56 lbs (.25 kg)

TT-S2B

- OPTIONS**
- Buna Standard **00**
 - Viton Standard **V0**
 - Buna, Override, Detent **0M**
 - Viton, Override, Detent **VM**
 - Buna, Screen **A0**
 - Viton, Screen **W0**
 - Buna, Override, Non-Detent **B1**
 - Viton, Override, Non-Detent **V1**
 - Buna, Screen, Override, Non-Detent **B3**
 - Viton, Screen, Override, Non-Detent **V3**
 - Buna, Screen, Override, Detent **B4**
 - Viton, Screen, Override, Detent **V4**

Note: use screen only if flow direction is from (1) to (2)

"V" COIL TERMINATION
(All DC Except as Noted)

DL Double Lead
(several types of termination can be attached on leads on request)

HC DIN 43650 (Hirschmann) - (AC&DC)
DI Deutsch - Integral DT04-2P

IMMERSION PROOF "D" TYPE

- DIA** "I" Coil AMP Superseal - Integral
- DID** "I" Coil Deutsch - Integral DT04-2P
- DIJ** "I" Coil AMP Jr. Timer - Integral
- DIM** "I" Coil Metri-Pack - Integral

- BODIES**
- Blank** Without Body
 - N** 3/4" BSP Ports
 - S** #12 SAE Ports

- VOLTAGE** (other voltages available on request)
- 12** 12 VDC
 - 24** 24 VDC
 - 22** 220 VAC without internal rectifier

W 40 / 2017

WARNING: the specifications/application data shown in our catalogs and data sheets are intended only as a general guide for the product described (herein). Any specific application should not be undertaken without independent study, evaluation, and testing for suitability.



4484 Boeing Drive Rockford, IL 61109 • USA • Phone +1 (815) 397-6628 • Fax +1 (815) 397-2526
mail: delta@delta-power.com • www.delta-power.com



Via Malavolti, 36 • 41122 Modena • ITALY • Phone +39 (059) 254895 • Fax +39 (059) 253512
mail: tecnord@tecnord.com • www.tecnord.com